

OUTDOOR PANEL

METAKOM

MK20.2-TM



PASSPORT

user`s manual

www.metakom.ru

To be completed by the repair company

Contents of the repair. Name and number according to the scheme of the replaced part or unit. The place and nature of the defect:

Signature of the person who carried out repairs _____

Repair date _____
(date, month, year)

Signature of the owner of the product, confirming the repair:

Stamp of repair company with the city:

1. PURPOSE	2
2. DISTINCTIVE FEATURES	4
3. OPERATING FUNCTIONS	5
4. SELF-TEST	6
5. TECHNICAL SPECIFICATIONS	7
6. INSTALLATION PROCEDURE	8
7. PREPARATION FOR WORK	13
7.1 OUTDOOR PANEL PROGRAMMING MODE	14
7.2 ENTER THE PROGRAMMING MODE	15
7.3 DESCRIPTION OF THE SECTIONS OF THE PROGRAMMING MODE	15
8. USER'S USE OF THE OUTDOOR PANEL	23
9. TRANSPORTATION AND STORAGE	24
10. MANUFACTURER'S WARRANTY	25
11. OUTDOOR PANEL COMPLETENESS	25
APPENDIX 1	26

1. PURPOSE

The outdoor panel of METACOM MK20.2-TM4 (hereinafter – the doorphone) is a specialized microprocessor system intended for installation in multi-apartment buildings, offices, as well as for organizing a system of selector communication with a number of subscribers up to 20.

As user keys are used electronic keys (hereinafter TM-Keys) METAKOM TM2002, METAKOM TM2003 (A, B) or Dallas iButtonm - DS1990A.

As terminal devices installed at the subscribers, we recommend TKP-01, TKP-05M, TKP-05M, TKP-10M, TKP-10M, TKP-12M, TKP-14M or other interphone handsets designed for doorphones with coordinate addressing system produced by METAKOM.

The doorphone provides a call signal to the subscriber's TKP, a duplex connection of the visitor to the subscriber, remote opening of the lock upon a signal from the TKP.

The lock can also be opened with a TM-key, using the code dialed on the call unit, or by pressing the EXIT button, installed at the entrance door inside the entrance.

To ensure the possibility of using different types of locks, the outdoor panel MK20.2-TM4 is available in two versions:

Full name of the model	Lock type	Terminal marking of terminal blocks	Description of the output node
MK20.2-TM4E	Electromagnetic lock without control board	LOCK - a line normally closed to the common lock wire GND	Powerful key transistor. When you open the lock, it turns off
MK20.2-TM4M	Electromechanical lock without control board-	LOCK – a line normally open to the common lock wire GND	Powerful key transistor. When you open the lock, it turns on.

Valid for filling

Tear-off coupon N1

For the warranty repair of the outdoor panel
METAKOM MK20.2-TM

To be completed by the manufacturer

Serial number of the product _____

Release date _____
(date, month, year)

Representative of the QC of the manufacturer

(QC stamp)

Address for return of the coupon to the manufacturer:

Russia, 241024, Bryansk city, Delegate street, 68, LTD "Metakom"

To be completed by a trade or installation organization

Sale date _____
(date, month, year)

Seller _____
(signature or stamp)

Date of commissioning _____
(date, month, year)

Installer _____
(signature or stamp)

The stamp of the organization that conducted the installation:

Cut-off line Counterfoil coupon N1 for warranty repair of the METACOM outdoor panel MK20.2-TM

Annex 1.

Code tables.

Table №1

№ sp.	1	2	3	4	5	6	7	8	9	10	11	12	13	14	15	16	17	18	19	20
Code	529	7970	8740	8362	9813	4966	8801	8433	0899	8307	1628	0278	3352	0961	9538	3923	3356	9077	4727	0139

Table №7

№ sp.	1	2	3	4	5	6	7	8	9	10	11	12	13	14	15	16	17	18	19	20
Code	2065	1627	1605	0053	9542	0102	8488	1273	5266	6436	6149	1118	0209	3338	0819	2643	723	358	549	0135

The output stage with a transistor is designed for direct control of the lock winding without the use of any additional control board or demagnetization.

The power supply of the call and lock unit can be provided from the METAKOM BP-2U power supply.

The full name of the calling panel consists of the following elements:

MK20.2 – TM4 E V N

----- - - - -
1 2 3 4 5

1. MK20.2 - model number;
2. TM4 - Support for electronic keys METAKOM TM2002, METAKOM TM2003(A,B) и Dallas iButton™;
3. E - for electromagnetic lock,
M - for electromechanic lock,
4. V - Built-in video camera and infrared illumination,
{пробел} - without video camera,
5. N - The doorphone supports networking.

2. Distinctive features

- Direct addressing of subscribers;
- Built-in switch for 10 subscribers;
- 2 ringer volume levels, 3 ringtones;
- Auto-collection of keys mode;
- Disable reading of some types of keys (prohibition of reading keys using the Dallas or TM2002 protocol);
- Use of special keys with individual coding
- Transfer of all the doorphone settings to a personal computer (or another doorphone) and back via the METAKOM adapter MKA-02U and the TM-key DS1996 (L). It is possible to configure all modes of operation of the doorphone and input subscriber RF (MF)-keys using a personal computer (PC) in a comfortable laboratory environment. The information prepared is transferred to the nonvolatile memory of the outdoor panel. A copy of this information is stored on the PC and used for subsequent servicing;
- Possibility of the organization of interphone network type 1 Master / 16 Slave (one main input, 16 additional);
- The possibility of diagnosing the system during commissioning (testing the hands-on subscriber with the output of the audio line parameters on the LED backlight);
- Correction of the parameters for determining the tube position for each subscriber separately (the adjustment can be carried out for each subscriber separately);
- Vandal-proof design - special keypad design, installation on site with a special key;
- Waterproof keyboard with illumination of each key, illumination of the key reader;
- Return to the outdoor panel factory settings, while storing recorded keys;
- Self-test on power up or on reset.

10. Warranty of the manufacturer

The manufacturer guarantees the compliance of the METAKOM MK20.2-RF outdoor panel (METAKOM MK10.2-MF) with the requirements of MTCM.420570.004 TU when the user applies the rules of use, storage and transportation.

Warranty period - 12 months from the date of sale, but not more than 18 months from the date of manufacture. Service life is 5 years from the date of manufacture. Without presentation of a coupon for warranty repair and (or) violation of the integrity of seals, mechanical, electrical or other types of damage caused by improper transportation, storage, operations or actions of third parties, no claims for quality are accepted and no warranty repair is performed.

Manufacturer's address:

Russia, 241024, Bryansk city, Delegate street, 68,

LTD "Metakom"

Tel / fax: (4832) 68-28-26

Tel. (4832) 68-37-95

<http://www.metakom.ru>

E-mail: os@metakom.ru

11. OUTDOOR PANEL COMPLETENESS

Outdoor panel.....	1 pc.
Passport.....	1 pc.
Fixing kit.....	1 pc.
Special key.....	1pc.
Packing box	1 pc



Товар сертифицирован

9. Transportation and storage

Packaged products can be transported by all types of transport, except unpressurized aircraft compartments and open decks of ships and ships, in accordance with the rules for the carriage of goods operating on this type of transport.

As a transport container the wooden boxes are used, the group and other containers, ensuring the safety of the goods during transportation.

Products should be stored only in a packaged form when there are no acidic, alkaline or other aggressive impurities in the surrounding air.

3. OPERATING FUNCTIONS

- Indication of modes of operation by backlighting the buttons of the keyboard;
- Sound control of button pressing;
- Call the subscriber by pressing a button on the call unit;
- Sound control of making a call to the subscriber (sending a ringing tone of another tonality, if the subscriber's handset is not packed);
- Duplex communication subscriber-visitor;
- Remote lock opening from the subscriber's TKP;
- Local lock opening by a set of a general or individual access code;
- Local lock opening by an individual TM-key;
- Local lock opening from the entrance by pressing the EXIT button;
- Sound signaling the use of an individual user code or TM-key on the TKP of the corresponding subscriber (function included on request);
- Ability to prohibit the maintenance of the user's TKP while maintaining access to the individual code;
- Code lock operation in common code mode, in individual codes mode or jointly (programmable);
- Adjustment of all parameters of work for the complete conformity to the requirements shown on a place of installation;
- Use the master TM-key to quickly enter the programming mode

4. SELF-TEST

When the power supply of the call unit is turned on, a self-test procedure is performed. When an error is detected, an appropriate sound signal and a light indication are output. If the EEPROM chip fails to initialize, the button illumination flashes 2 times. If the error is caused by the fact that a new (or previously used in the other device) EEPROM was installed, perform a full initialization of the EEPROM (see section 7.3). If the error message continues to appear - replace the EEPROM chip. If a key fault is detected, the button illumination flashes 3 times, its operation is blocked, and the function of opening the door lock from the exit button and TM-keys is operable. When the audio line is shorted, an error signal sounds and a twofold flashing of the button illumination, an error signal sounds when the line is broken and the button illumination flashes once.

8. USER'S USE OF THE OUTDOOR PANEL

After power on, the doorphone is in standby mode. Subscriber numbers are highlighted in red.

After pressing the user number button, the visitor establishes a connection with the user's TKP and provides the set number of call signals. If the subscriber does not pick up the handset, after the set number of ring signals has been exhausted, the call unit returns to standby mode. When the receiver is off, the call signals are given in a different key. In this case, the subscriber needs to hang up, wait for the call signal of another tone and lift the handset.

When the subscriber picks up the handset, the highlight of the corresponding user's number changes to green, the connection with the subscriber is established and the visitor can talk.

The lock is opened by pressing the button on the TKP of the subscriber. This turns on the highlighting of all subscriber numbers in green.

If the subscriber has hung up, the conversation is interrupted and the call unit returns to standby. You can also interrupt the conversation by pressing any button on the outdoor panel.

After the set time limit has expired, the conversation will be interrupted automatically (see section 7.).

If the function of "general" or "individual" codes is activated, then to enter the code for door opening you must press and hold any button until two sound signals appear. After that, it is necessary to enter the code on the left side of the keyboard (factory general code is 1234, the individual code is taken from the table). If the code is entered correctly, the lock is opened.

If the network protocol is activated, then at the time of a network call, the number illumination goes out. When the connection with the subscriber is established, the numbering of the numbers in red will flash. In this case, dialing the number on the keyboard is blocked. The door is opened by the exit button or stored in the memory of the TM-key.

5. TECHNICAL SPECIFICATIONS

Chapter №27 Number of subscribers served.

Used to set the number of subscribers served. It is set if the number of subscribers served by the doorphone is less than 20.

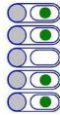

Chapter №28 Enable the mode for reading copies of the TM2002 key.

It is used to allow reading of copies of the TM2002 key based on the TM 2004 key blank. After entering the section, you must press "1" "19" to allow reading the copies of the TM2002 key or "0" "19" for the prohibition. The factory setting is that reading copies is prohibited.

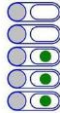

Chapter №29 Select the melody of the sound signal.

Used to set one of 3 options for ringing sound. After entering the section to select the first melody, you need to dial "1" "19", the second - "2" "19", the third - "3" "19".

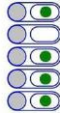

Maximum resistance of the entrance access line.	Max 30 Ohm
Maximum number of subscribers served	20
Maximum subscriber number (for network version)	999
Maximum number of TM-keys	975
Number of TM-keys per apartment	To 975
Offset of subscriber numbers (for network version)	1...999**
Number of ringing signals applied to the TKP	2...62**
Lock opening duration	2...100 sec.**
Restriction of the conversation duration	40...240 sec.**
Maximum number of individual codes	20
Maximum number of the code table	255
Number of subscriber code digits	4
Number of the total code digits	4
Number of the master code digits	6
Operating temperature range	-30...+40°C***
Relative humidity (at 35 ° C)	95%
Supply voltage (DC)	15...18V
Maximum current consumption in standby mode (without a video camera), max	180 mA
Peak consumption current (when a call signal is applied to a subscriber's TKP)	210 mA
Overall dimensions of the block, max (height x width x thickness)	180 x 202 x 40 mm.
Block weight without package, max	0,8 kg.

* - when using multiple switches

** - programmable parameter.

*** - for modifications with index "V" operating temperature range -10 ... + 40 ° C

6. INSTALLATION PROCEDURE

ATTENTION! There is a dangerous voltage in the power supply - 220V. Do not perform installation and maintenance work with the power turned on. In the outdoor panel and other doorphone devices, except for the power supply unit, there are no voltages exceeding 18V.

The following sequence of actions is recommended:

1. Carefully study this instruction manual and block diagram.
 2. Prepare a niche for installing the outdoor panel (see the markup in Figure 1).
 3. Install the power supply, the lock and the opening button from the room. Connect the outdoor panel housing to the protective ground wire.
 4. Set the interphone handsets in the apartments (TKP).
 5. Install the wiring. Make taps from the loops and connect the TKP of all the subscribers. (Figure 2)
 6. Check that the connections are correct.
 7. Turn on the power, the button illumination in red should turn on, enter the programming mode (see section 7.2) and perform the following actions:
 - A) Change the access code to the programming mode and, if necessary, program the master TM-key. Be careful when entering the code. **WRITE MASTER CODE!**
 - B) If necessary, set the shift of the subscriber numbers range (see section 7.3). This parameter should always be set first, since all further operations with subscriber numbers will depend on the set offset.
 - C) Program subscriber TM-keys.
 - D) If the doorphone will be used on the network, it is necessary to enter the number of the first subscriber, the network number (from 1 to 16), the number of subscribers served (see section 7.3). Attention! If the first subscriber number is entered different from "1", then the offset of the subscriber numbers must be taken into account when setting the next parameters. As the Master doorphone, the outdoor panel MK2003.2-TM4E(V)N can be used.
 - E) If a common code is used in the code lock mode, then change the common code and switch the outdoor panel to the common code mode. Write down the general code (see section 7.3).
 - F) If individual codes are used, create a code table. (See section 7.3). Record the code table number.
 - G) If necessary, change the duration of the ringing signal, the duration of the lock opening, the duration of the call restriction, and so on. Factory settings in most cases are optimal.
- NOTE: Items a ... g can be pre-made using a personal computer. In this case, the prepared information is transferred to the outdoor panel memory via the METAKOM MKA-02U adapter and the TM-key DS1996 (L).
8. Check the operation of the call unit in the intercom mode and in the code lock mode.
 9. Secure the outdoor panel to a previously prepared niche using the supplied hardware kit.

Chapter №22 Reading the electronic media DS1996 (L)

Used to transfer information from the TM-key DS1996 (L) to the memory of the outdoor panel. To read data from the DS1996 (L), press "1". Then attach the key DS1996 (L) to the reader, the data transfer will begin. If an error occurs, an error signal will sound. A sign of the end of the transfer of information is the audio signal of the end of the recording and the highlight of the right row of buttons in green.

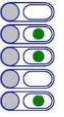

Warning: be sure to wait until the reading is completed correctly, otherwise the outdoor panel may fail.

Chapter №23 Changing the system code

Used to change the access code to programming mode. After entering the section, you must type "1", then type the new system code. After dialing the 6th digit, the new code will be automatically saved.

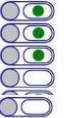

Chapter №24 Master-key recording

Used to record a master key for quick access to the programming mode. Any key supporting the Dallas protocol (TM2003, DS1990, DS1996) can be used as the master key. After entering the section, you need to press: "1" - to record the master key, "0" - to delete the master key. After entering the recording mode, you must attach the key to the reader, if the key is read correctly, the master key will be recorded.



Chapter №25 Return to factory settings.

Used to set the factory settings. After entering the section, you must press "1" to confirm the installation, then the parameters will be automatically changed, and the key database will not change.

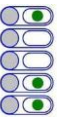

Chapter №26 Enabling the network protocol

Used to disable the network protocol or set the network number of the doorphone working on the network. To disable the network protocol, you must press "0", to enable the network protocol, you must set the network number of the doorphone. It can be from 1 to 16. The network number is set in accordance with the subscriber numbers being serviced, i.e., the doorphone with the network number "1" will serve the initial numbers of the subscribers, and with the network number "16" - the last numbers of the subscribers.



Press it, then press "11". Manual correction is described in P 19, 20.

Chapter №19 Setting the threshold for determining the position of the tube

Used to adjust the range of the tube. If there is an incorrect determination of the position of the tube (long line, use of some video monitors with adapters, etc.), you can adjust the threshold position of the tube in a certain range. The threshold shift is in the range 1 ... 100. Correctness of the adjustment can be verified using Chapter 18.

After entering the section, it is necessary to dial the subscriber's number, for which you need to change the threshold and press "19", then dial the threshold offset value and press "19". If it is necessary to conduct actions for all subscribers, then instead of the subscriber number, press "0" next "19".

Chapter №20 Setting the threshold for the opening of the lock button on the subscriber's handset

Used to adjust the threshold for the opening of the lock button on the subscriber tube. If there is an incorrect detection of the lock opening signal (long line, use of some video monitors with adapters, etc.), then it is possible in a certain range to adjust the threshold of operation of the lock opening button on the subscriber tube. The threshold shift is in the range 1 ... 100. Correctness of the adjustment can be verified using Chapter 18.

After entering the section, it is necessary to dial the subscriber's number, for which you need to change the threshold and press "19", then dial the threshold offset value and press "19". If it is necessary to conduct actions for all subscribers, then instead of the subscriber number, press "0" next "19".

Chapter №21 Recording of electronic media DS1996 (L)

Used to transfer information from the memory of the outdoor panel to the TM-key DS1996 (L). To write data to the DS1996 (L), press "1". Then attach the key DS1996 (L) to the reader, the data transfer will begin. If an error occurs, an error signal will sound. A sign of the end of the transfer of information is the audio signal of the end of the recording and the highlight of the right row of buttons in green.

Warning: be sure to wait for the correct end of the record, otherwise later when reading incorrect information in the work of the outdoor panel there may be failures.

10. In versions of the outdoor panel with index V, the built-in video camera can be powered from external or internal voltage of 12V. For power supply from the internal source, the terminals "+ UV" and "+ 12V" must be closed.

11. Make a note in the tear-off coupons about the date of commissioning the unit. If the volume of the call is insufficient, adjust the required parameters (microphone sensitivity and speaker volume) by trimmer resistors on the back of the outdoor panel.

If the volume of the call is insufficient, adjust the required parameters (microphone sensitivity and speaker volume) with trim resistors on the back of the call unit.

If possible, install the power supply in the boxes, niches, at the ceiling. The power supply must be installed within 15 meters of the outdoor panel. The "EXIT" button provides opening of the lock when leaving the entrance and is installed near the entrance door inside the entrance.

To reduce the influence of climatic factors (low temperature, high humidity, frost, dew), the outdoor panel and the lock should be installed on the second door of the entrance located in the vestibule.

The cross-sections of the wires connecting the power supply unit to the outdoor panel and the lock must be at least 0.35 mm² (KSPV 2x0.64 or CVVC 2x0.5), the rest - not less than 0.12 mm². As a connecting wire, it is recommended to use a wire with colored insulation of cores. To reduce the influence of external influences, the connection is recommended to be carried out with a shielded cable. For installation of video equipment use a coaxial cable of the type RK-75.

For doorphones MK20.2 with a network function when installing a digital line (AV), use a twisted pair. On long communication lines on the "Master" and the last "Slave" doorphone, install 120 Ohm resistors between the terminals AB.

The "+" terminal of the TKP is connected to the bus of tens, and the "-" TKP is connected to the bus of units. Before connecting the TKP, the line must be checked for a short circuit. Line resistance should not exceed 30 ohms.

There is protection against short circuit of the line in the doorphone. At this time, communication with the TKP will be impossible. All other functions are available. Installation of other doorphone units is carried out in accordance with the passports for these units.

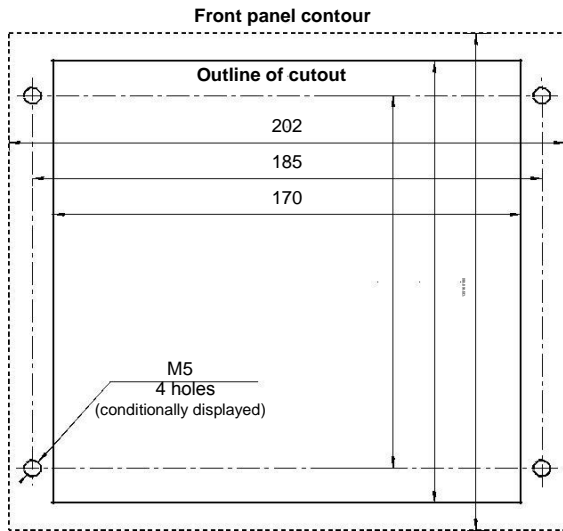
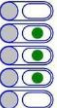

Fig. 1. Markup for the installation of the outdoor panel.

Chapter №14 Changing the code table number

Used to generate a new table of individual codes. After entering the section, you need to dial the table number and press "19", the maximum value is 250. Some code tables are in Appendix 1.



Chapter №15 Changing individual code

Used to enter a new individual code in the set individual codes table. After entering the section, you need to dial the number of the subscriber for which you need to change the code, press "19". Next, you need to dial a new individual code. After dialing the 4th digit, the new code will be automatically saved.



Chapter №16 Enable subscriber notification by code or key.

Used to activate the alert mode of the subscriber when using an individual code or key. After entering the section, you need to dial the number of the subscriber for which you want to turn on the alert mode, press "19", then press: "0" "19" - to turn off the mode, "1" "19" - to activate the mode. If it is necessary to conduct actions for all subscribers, then instead of the subscriber number, press "0" next "19"



Chapter №17 Internal switch test

Used when installing or failing the outdoor panel operation. After entering the section, press "1" to start the test. After the start, the subscriber's pipes will alternately be connected and a short beep will be delivered.



Chapter №18 Test caller tubes

Used to determine the position of the handset at the subscriber during installation or the failure of the call unit. After entering the section, you need to dial the number of the subscriber for which you need to check the handset, press "19", the connection will be established and the value of the tube's position will be displayed in the left row of the keyboard backlight: "1" - short circuit, "2" - the tube lies, "3" - the tube is removed, "4" - the line is broken.

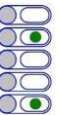

If the threshold values are different, then correction is necessary. To automatically correct the threshold for determining the position of the subscriber tube, it is necessary to lay the handset on the stand, then press "11". To automatically correct the threshold for the opening of the lock on the subscriber tube, it is necessary to remove the tube from the stand, press the lock release button

A short beep) delivered when the lock is opened (for example, if a value of 110 is entered, the unlocking time will be $110 - 100 = 10$ sec)

Chapter №9 Talk duration

Used to set the required duration of the call of the visitor to the subscriber. After entering the section, dial the talk time in seconds and press "19", the maximum value is 240.

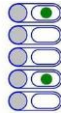

Chapter №10 Number of ringtones

Used to set the number of ringing tones applied to the TKP. The call signal to the subscriber's TKP consists of an alternation of a musical fragment and a pause. This function determines the number of music fragments to be sent to the TKP. After entering the section, you need to dial the number of signals on the keyboard and press "19", the maximum value is 60.

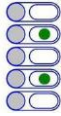

Chapter №11 Ringing volume

Used to set the desired sound level of the ring signal in the handset. After entering the section, you need to dial the number of the subscriber for which you need to change the volume of the call, press "19", then press: "1" "19" - to set the minimum volume level, "2" "19" - to set the maximum volume level, if it is necessary to conduct actions for all subscribers, then instead of the subscriber number, press "0" and then "19".

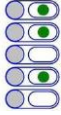

Chapter №12 Inclusion of the general or individual code

Used to allow the work of a common or individual code. After entering the section, you need to press: "1" "19" - to allow the work of the general code, "2" "19" - the prohibition of the work of the common code, "3" "19" - permission for the work of the individual code, "4" "19" - prohibition of the work of individual code. For simultaneous work of the general and individual code it is necessary to allow the work of the general, then individual code.

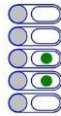

Chapter №13 Changing the General Code

Used to enter a new common code. After entering the section, you must type "1", then type a new common code. After dialing the 4th digit, the new code will be automatically saved.

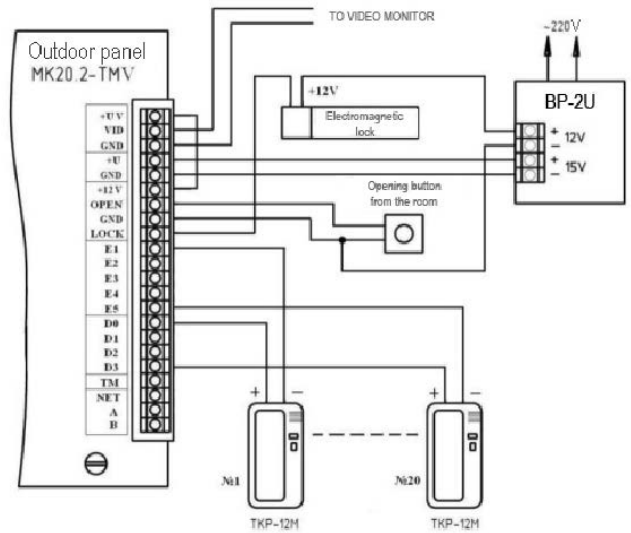
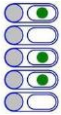

Fig. 2 Example of mounting the outdoor panel MK20.2-TMV

Chapter №4 Erasing the electronic keys

Used to delete TM keys from the memory of the outdoor panel. Removal is carried out in 3 modes: deleting "shared" keys, deleting "individual" keys and deleting all keys. After entering the section, you need to press: "1" "19" - to delete "common" keys, "2" "19" - delete "individual" keys, "3" "19" - delete all keys. After entering the subsection of deleting "individual" keys, it is necessary to enter the subscriber's number and press "19". When deleting the keys, a beep will sound and a "scrolling line" will appear on the indicator.



Chapter №5 Including key coding

Used to specify an individual key number. Using the adapter MKA-02U, you can write the individual code into the TM-key MK2004. If the same code is recorded in the doorphone, the doorphone will react only to keys with such a code, so it becomes possible to exclude the use of non-original TM keys.

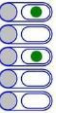

After entering the section, you must enter the code (number from 1 to 255) and press "19". If the input is correct, an audible signal will sound and a "running line" will appear on the indicator. To disable this function, after entering the section, enter "0" and "19".

Chapter №6 Disabling the reading of certain types of electronic keys

Used to block the operation of the electronic keys reading protocols. After entering the section, you need to press: "1" "19" - to enable reading of the keys TM2002, "2" "19" - prohibition of reading the keys TM2002, "3" "19" - read permission for TM2003 and Dallas, "4" "19" - the prohibition of reading TM2003 and Dallas.

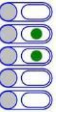

Chapter №7 Activation of electronic key collection mode

Used to automatically record subscriber keys when the key is applied to the reader. This opens the door. After entering the section, you need to press "1" "19" to allow autoscore or "0" "19" to disable autoscore.



Chapter №8 Time of opening the lock

Used to set the required duration of the lock opening. After entering the section, you need to dial the opening time in seconds and press "19", the maximum time for input is 100 seconds. If you enter a value greater than 100, the type of the sound melody

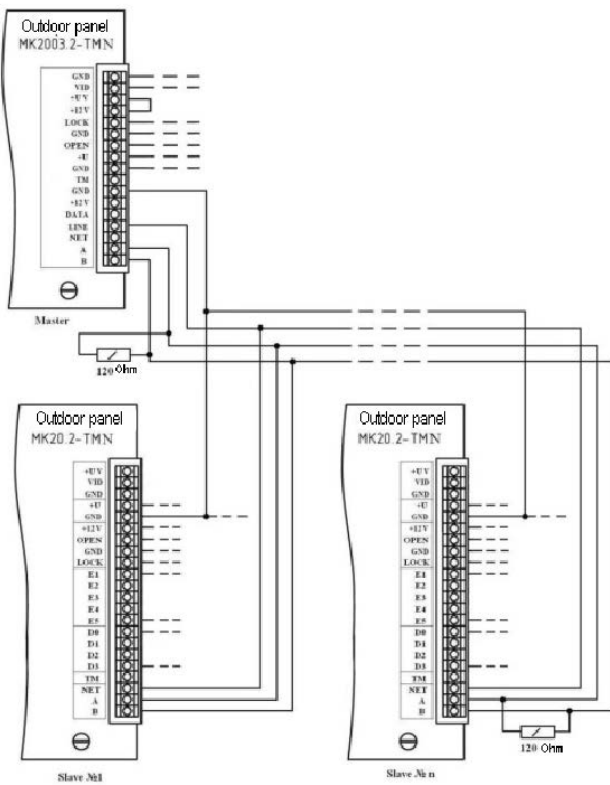
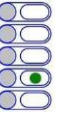

Fig. 3 An example of installation when combining intercoms in a network.

This setting affects all subsequent changes in the parameters of the outdoor panel, so it must be performed at the beginning of the change of the subordinate parameters of the outdoor panel.

Chapter №2 Disconnecting subscribers

Used to disconnect the subscriber's service. When you call a disconnected subscriber, an erroneous beep will sound. After entering the section, dial the number of the subscriber to be switched off, press "19", then press:

"0" "19" - if it is necessary to disable maintenance

"1" "19" - if you want to enable maintenance

If the input is correct, an audible signal will sound and a "running line" will appear on the indicator. If it is necessary to conduct actions for all subscribers, then instead of the subscriber number, press "0" next "19".

This setting affects all subsequent changes in the parameters of the outdoor panel, so it must be performed at the beginning of the change of the subordinate parameters of the outdoor panel.

Chapter №3 Recording the electronic keys

Used to enter TM keys in the memory of the outdoor panel. The recording of TM-keys is carried out in 2 modes:

- the mode of "common" keys,

- mode of "individual" keys.

In the mode of "common" keys, TM keys are written to the common database without pointing to a specific subscriber, and the function of giving the subscriber's alert signal is not available. In the mode of "individual" keys TM key is written to the number of a particular subscriber.

If a key overflow occurs during the recording of TM keys, an error signal will be issued and further key recording will not be possible.

After entering the section, you need to press: "1" "19" - to write the public keys, "2" "19" - to record individual keys. In the common key registration mode, attach the key to the reader, the key will be recorded, if the key is already written, an error signal will sound. In the mode of recording individual keys, it is necessary to dial the number of the subscriber to which the keys will be recorded, press "19" and attach the key to the reader, the key will be recorded, if the key is already recorded, an erroneous signal will sound. If the key is correctly written, an audible signal will sound and a "running line" will appear on the indicator.

7. Preparation for work

Preparing the doorphone for work consists in programming parameters to meet the requirements of the system at the installation site, and input subscriber TM - keys. Programming is carried out directly from the outdoor panel keypad or on a personal computer using a special program, the METAKOM MKA-02U adapter and the Dallas TM key and the DS1996 (L) Buttontm. All parameters are stored in the non-volatile memory of the device (hereinafter EEPROM), which ensures the safety of data in the absence of supply voltage.

When the call unit is delivered, the EEPROM contains the initial settings shown in the table.

N	Parameter	Value
1	Offset of subscribers	No
4	Ban of subscribers	All are allowed
5	Types of keys	All are allowed
6	Auto set mode	Disabled
7	Opening time of the lock	4 sec
8	Talk duration	90 sec
9	Number of ringtones	10
10	Using generic or individual code	Codes disabled
11	Code table number	1
12	Enable subscriber notification by key or code	Disabled
13	Tube position detection threshold level	5
14	The threshold level of the opening button lock on the subscriber tube	5
15	System code	123456
16	Master key	Not programmed
17	Network protocol	Disabled
18	Reading copies of TM2002	Forbidden

In programming mode, it is possible to repeatedly change any of these parameters, as well as return all settings to their original state.

You can view the serial number in the outdoor panel. The serial number is set at the factory and is not subject to change in the future. For viewing, it is necessary to press and hold any button, turn on the power supply, hold the button until an audible signal appears, then the serial number numbers are displayed, the first number is the highest digit of the serial number number, then seven remaining values are extracted in order eight-digit serial number.

7.1 OUTDOOR PANEL PROGRAMMING MODE

B In the programming mode, access to the sections is made by typing the corresponding section number in the left row of the keyboard and pressing the button "19" (second from the bottom in the right row), if there is a subsection, access to it is done by pressing the corresponding buttons. Exiting the sections and the programming mode is done by pressing the button "20" (the lower one in the right row). If no changes have been made or the buttons are pressed, the partition or programming mode will automatically exit after a while. The table shows the names of the sections and the combination of buttons for accessing them.

N menu	Menu name	Enter the menu	Submenu	Enter the submenu
1	First subscriber number	«1» «19»	---	---
2	Disconnecting subscribers	«2» «19»	---	---
3	Recording keys	«3» «19»	Shared keys Individual keys	«1» «19» «2» «19»
4	Deleting the keys	«4» «19»	Shared keys Individual keys All keys	«1» «19» «2» «19» «3» «19»
5	Enabling Key Encoding	«5» «19»	---	---
6	Disable key types	«6» «19»	Read permission for TM2002 Prevent reading of TM2002 Read permission of TM2003 Prevent reading of TM2003	«1» «2» «3» «4»
7	On auto set key mode	«7» «19»	---	---
8	Opening time of the lock	«8» «19»	---	---
9	Talk duration	«9» «19»	---	---
10	Ringing time	«1» «10» «19»	---	---
11	Ringing volume	«1» «1» «19»	---	---
12	Include a single or shared code	«1» «2» «19»	Enable shared code Disable shared code Enabling the in-line Code Disable the in-line code	«1» «2» «3» «4»
13	Changing the general code	«1» «3» «19»	---	---
14	Changing the code table	«1» «4» «19»	---	---
15	Changing the code	«1» «5» «19»	---	---
16	Notification by code or key	«1» «6» «19»	---	---
17	Embedded Switch Test	«1» «7» «19»	---	---
18	Subscriber Tube Test	«1» «8» «19»	---	---
19	Setting the threshold for determining the position of the tube	«1» «9» «19»	---	---
20	Setting the threshold for the opening of the lock button on the subscriber tube	«2» «10» «19»	---	---
21		«2» «1» «19»	---	---
22	Recording to DS1996	«2» «2» «19»	---	---
23	Reading from DS1996	«2» «3» «19»	---	---
24	Changing the system key	«2» «4» «19»	Delete the master key Select the master key	«10» «1»
25	Factory settings	«2» «5» «19»	---	---

26	Enable network protocol	«2» «6» «19»	---	---
27	Number of subscribers served	«2» «7» «19»	---	---
28	Enabling the mode of reading copies of the TM2002 key	«2» «8» «19»	---	---
29	Select the melody of the sound signal	«2» «9» «19»	---	---

7.2 ENTER TO PROGRAMMING MODE

To enter the programming mode, you need to know a special master code or a programmed master key.

A) Enter the programming mode using the master code.

When the call unit is in standby mode, you must press and hold any button, wait for 2 beeps to sound, continue to hold the button until 3 beeps sound, while the backlight of the left row of the keyboard starts flashing green, then dial on the keyboard in the left row, the master code ("123456" - the factory master code), with each press followed by a beep and turning on the backlight in the right row of the keyboard. After that, if the code is entered correctly, the outdoor panel goes into the programming mode, the sign of finding in the programming mode is the highlight of the left row in green.

B) Enter the programming mode using the master key.

When the call unit is in standby mode, you must press and hold any button, wait for 2 beeps to sound, continue to hold the button until 3 beeps are heard, then the backlight of the left row of the keyboard will turn green, then dial the code on the keypad 0, 0, 0, 0, 0. Then attach the master key to the reader. After the master key is identified, it will enter the programming mode.

7.3 DESCRIPTION OF THE SECTIONS OF THE PROGRAMMING MODE

On the right side, in the description of the sections of the programming mode, there is an image of the illumination of the right row of the keyboard while in this section. To enter values for numbers greater than 9, press the buttons corresponding to the number in the left row. To enter the number 10, you must press "1", "0", to enter the number 11, you must press "1", "1" and so on.

Chapter №1 Setting the Offset of Subscribers.

Used to set the offset of subscriber numbers if the number range exceeds the maximum value of the subscribers served. After entering the section, you need to dial the first subscriber number and press "19". An indication of the saving of the parameter is the sound signal the appearance of a "running line" of button illumination.

